



Raptor



Configurable Multi Applications Power Protection

Voltage Sag – Momentary Interruptions – Swell – Brownouts – Harmonic – Frequency Conversion

“...we're relying on an electrical grid that's increasingly unstable, underfunded and incapable of taking us to a new energy future.”

~ Gretchen Bakke

Cultural Anthropologist, Institute for European Ethnology at Humboldt University in Berlin

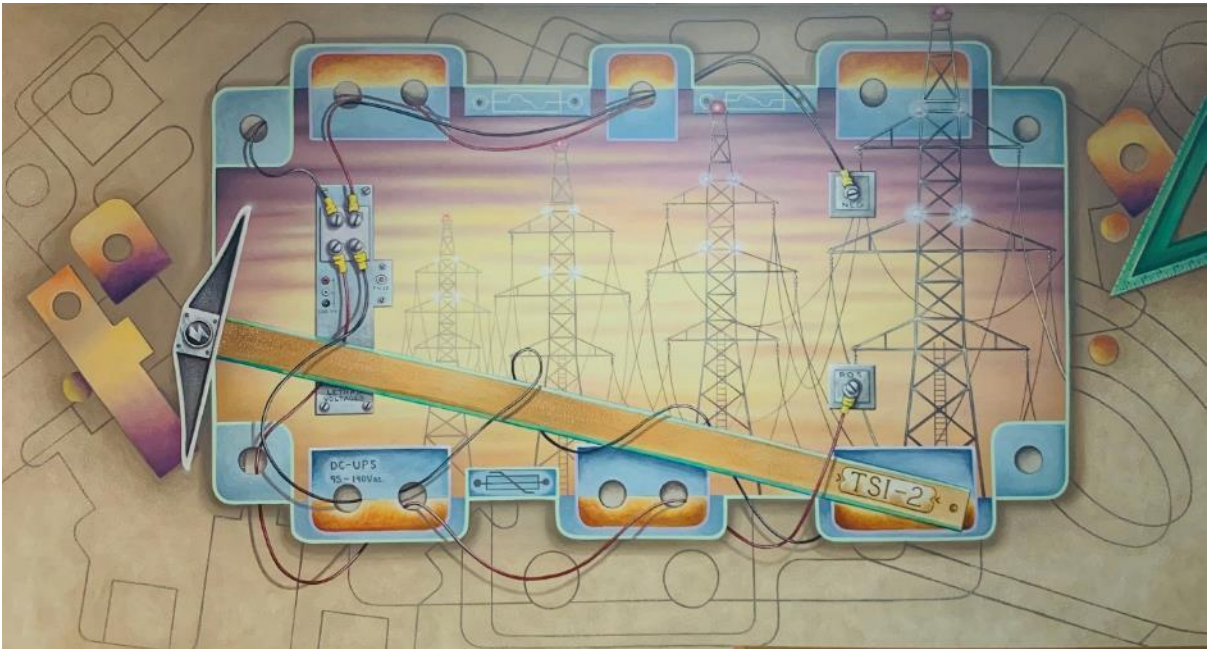

- Today's high speed and sensitive industrial equipment, quality of power is of utmost important to ensure high uptime percentage.
- Ironically, power distribution system has grown more complex as well as many systems not getting upgraded, the quality of power will be questionable in many parts of the world.
- Power quality problems encompass different phenomenon and there is not a one-size-fits-all solution to power quality problems.
- Inspired by Raptor, the Bird of Prey, which is swift, adaptable and powerful, TSI Power is committed to offer a unique power protection solution for the industries.

What is Raptor

- Raptor power platform are designed with the latest advanced power electronics technologies, by a team of TSI industry experts in the area power quality and power conversion.
- It is a flexible, scalable industrial power conversion solution.
- Features parallelable three phase current regulated IGBT converter modules controlled over a high-speed digital data link from a DSP.
- Configurable for a variety of power electronic application.



Raptor Power Converter



- The Raptor Power Converter is the heart of the entire series of Raptor power protection systems.
- It consists of power converter modules which can be configured to suit different applications.
- By pairing the Raptor Power Converter with different system enclosures, various Raptor's family of product can be realized.

Raptor Family of Power Solutions

We envision our users to be able to mitigate their various power quality with a single advanced power electronic platform. This will ensure high reliability, efficiency and cost effectiveness. Using the core Raptor Power Converter, various power quality solution can be configured.

The following are the available power quality solution that can be configured from the Raptor Power Converter. We name the solutions with the names of the various bird of prey in the Raptor family.

- Voltage Loss Compensator (VLC) - **“Red Tail”**
- Momentary Voltage Restorer (MVR) - **“Sparrow Hawk”**
- Continuous Voltage Regulator (CVR)- **“Falcon”**
- Continuous Voltage Conditioner (CVC) - **“Merlin”**

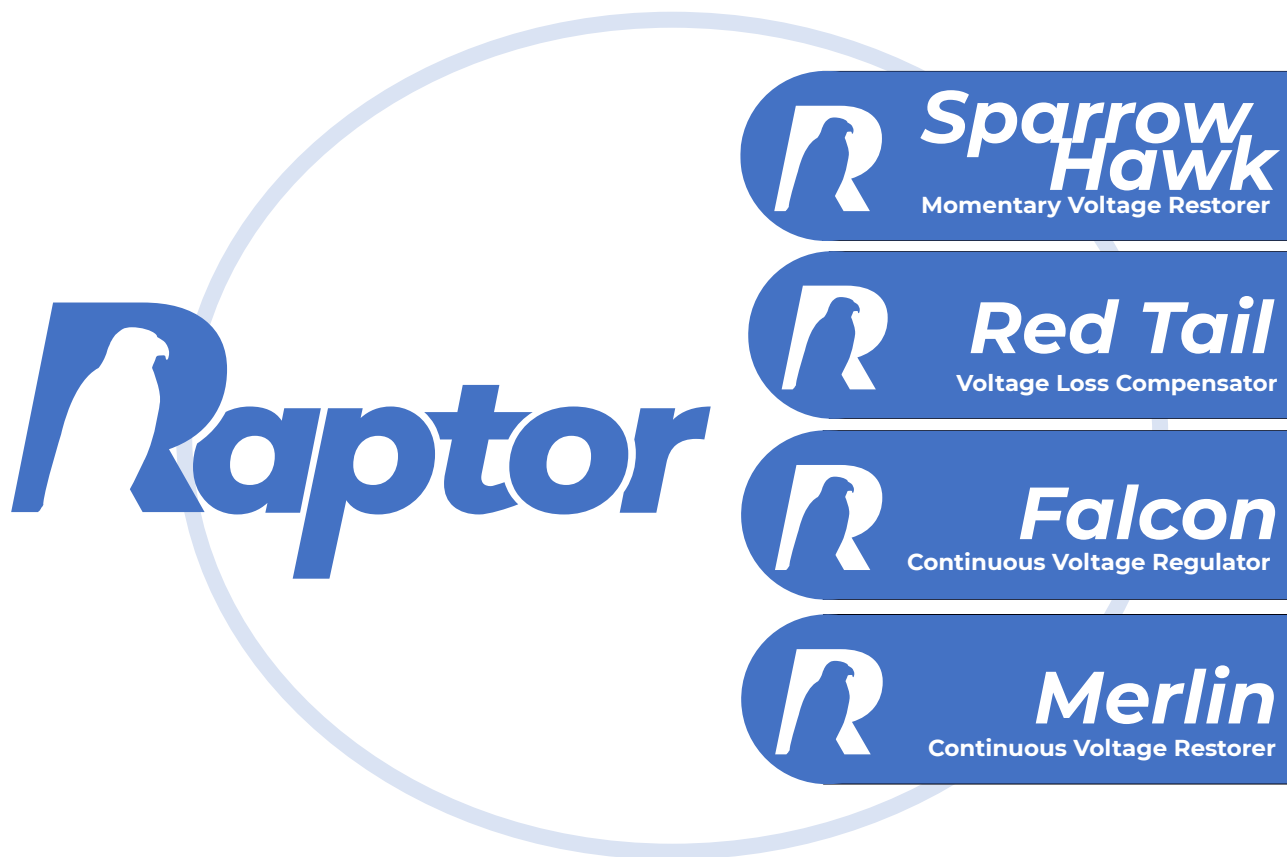

Which Raptor solution for you

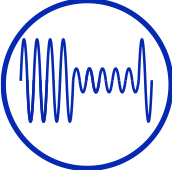
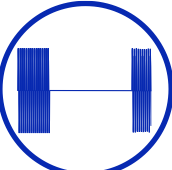
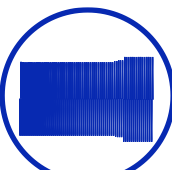
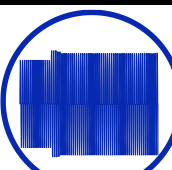
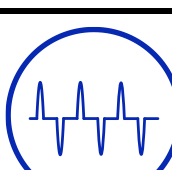
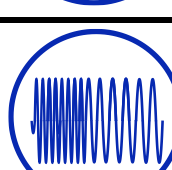
	Sparrow Hawk Momentary Voltage Restorer	Red Tail Voltage Loss Compensator	Falcon Continuous Voltage Regulator	Merlin Continuous Voltage Conditioner
 <i>Voltage Sag</i>	○	○	○	+
 <i>Momentary Outage</i>	○	○	X	X
 <i>Brownout</i>	X	X	○	+
 <i>Swell</i>	○	X	○	+
 <i>Harmonic</i>	X	X	X	○
 <i>Frequency conversion</i>	X	X	X	○

○ Standard function + Optional function X Function not available



Red Tail is a series of energy storage-based voltage loss compensator (VLC). It is made up of the Raptor Power Converter cabinet, system cabinet and the energy storage cabinet. It has ultra-fast response time, high efficiency, and the option of both ultracapacitor or batteries as energy storage.

Red-Tail typical block diagram

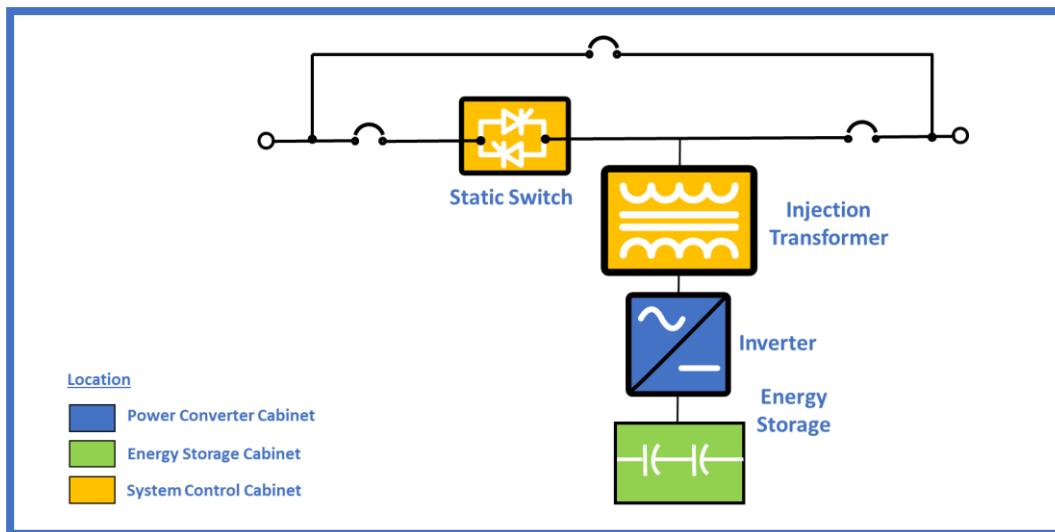



Falcon is a series of non-energy storage-based continuous voltage regulators (CVR). It is made up of the Raptor Power Converter cabinet and system cabinet. It has ultra-fast response time, and high efficiency.

Falcon typical block diagram

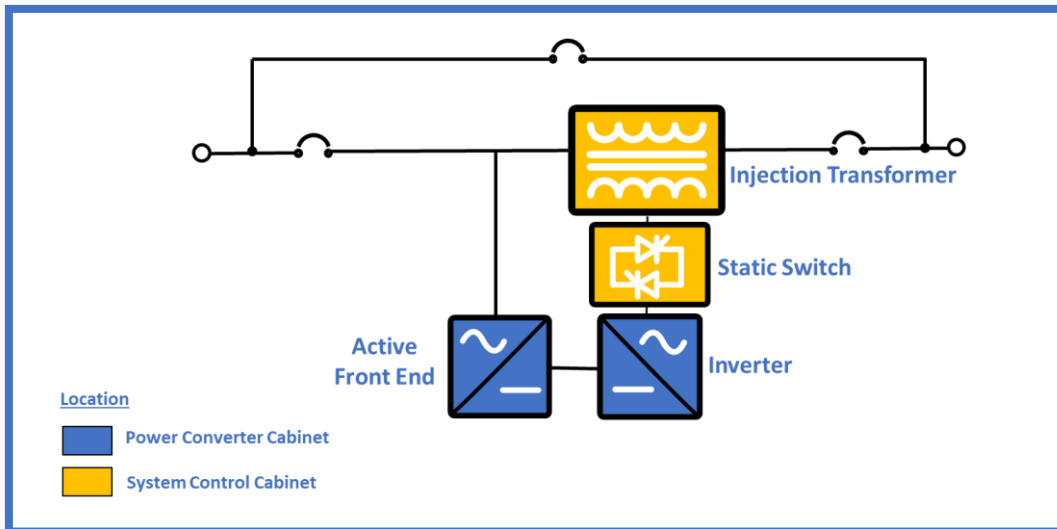



Merlin is a series of Continuous Voltage Conditioner with optional voltage regulation functionality. It uses the Raptor Power Converter for active harmonic filtration and frequency conversion. It has ultra-fast response time, and high efficiency.

Merlin typical block diagram

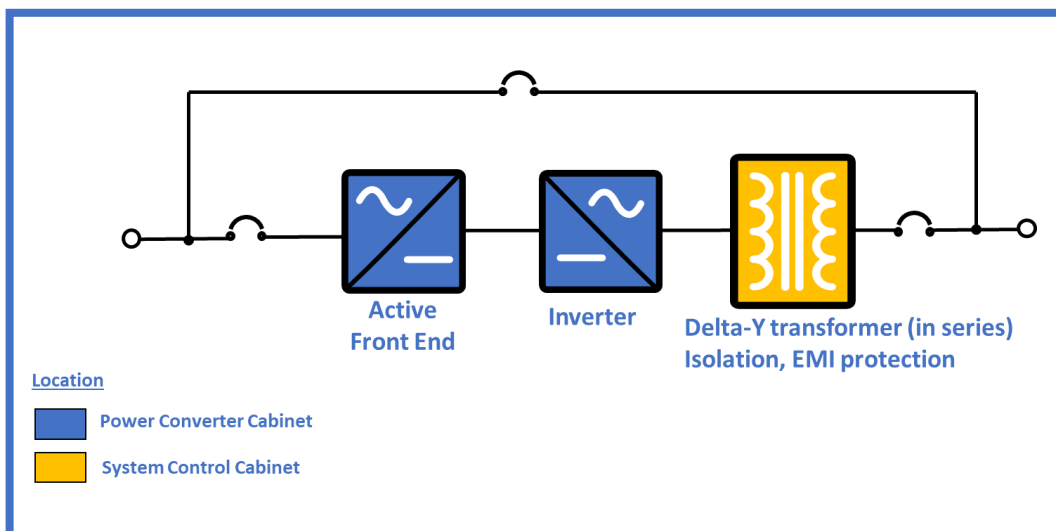

Sparrow Hawk MVR Reference Technical Specifications

AC Input

Nominal voltage	200/208/220/380/400/415/ 480/ 600 VAC
Operating voltage range	+/- 10% of nominal
Nominal operating frequency	50/60 Hz auto select
Operating frequency range	+/- 4 Hz
Power factor	0.5 lagging to 0.9 leading
Crest factor	Maximum 2
Overload capacity	120% for 60 s 150% for 30 s 200% for 10 s 300% for 5 s
Termination	Terminal block

AC Output

Voltage sag protection magnitude and duration	<i>Three Phase:</i> 90-50% nominal voltage for 7 seconds (exceeds SEMI-F47 curve) <i>Three Phase:</i> 50-0% nominal voltage for maximum 200ms at 0.9 Power Factor
	<i>Single Phase:</i> 90-0% nominal voltage for 7 seconds (exceeds SEMI-F47 curve, IEC, Power Vaccine)
Output voltage restoration	200/208/220/230/380/400/415/480 VAC, typically greater than 90% of nominal.
Voltage correction response time	Less than 2 ms
Efficiency	99% [400 – 480V] - 98% [200 – 380V] typical (under 50~100% load condition)
Termination	Terminal block

Mechanical

Cabinet construction	Light beige powder-coated galvaneal cabinet with casters
Emergency mechanical bypass	Available as option.
Cabinet environmental rating	IP 20 (for use in protected indoor environments)
Cooling method	Active Convection
Cable entry	Bottom or side entry
Noise	Less than 60dB (1 meter)

Environment

Operating altitude range	From 0 to 2,00 meters above sea level (without derating)
Operating temperature range	0 to +40 °C
Operating humidity range	0 to 90% relative humidity (non-condensing)

Communication

Communication protocol	Ethernet / Modbus TCP
Display	7" LCD Touch Screen Display

Design Standard

UL, CE and SEMI F47

Warranty

2 Years

Red Tail VLC Reference Technical Specifications

AC Input

Nominal Voltage	200 / 208 / 220 380 / 400 / 415 460 / 480 / 600 VAC
Source Type	Three phase wye (4 wires plus ground) consult factory for other types.
Operating Voltage Range (static bypass)	± 10 % of nominal (adjustable)
Nominal Operating Frequency	50 / 60 Hz (auto select)
Operating Frequency Range	+/- 4 Hz
Power Factor	0.5 lagging to 0.9 leading
Maximum Crest Factor	2
Overload Capacity (static bypass)	120 % for 60 s 150 % for 30 s 200 % for 10 s 300 % for 5 s 500 % for 1 s

AC Output

Voltage Sag & Momentary Interruption Protection Magnitude and Duration	Three-phase: 90-0 % nominal for 500 ms (standard model) to 5 sec (extended model)
Voltage Swell	Three-phase: 115 % of nominal for maximum 5 sec
Output Voltage Restoration	> 95 % of nominal (typical)
Voltage Correction Response Time	< 2 ms (typical)
Typical Efficiency (50~100% load)	99 % (400 – 480V) 98 % (200 – 380V)

Mechanical

Cabinet Construction	Light beige powder-coated galvanneal cabinet
Fail Safe Bypass	Optional
Maintenance Bypass	Optional
Cabinet Environmental Rating	NEMA 1 / IP 20 (for use in protected indoor environments)
Cooling Method	Active convection
Cable Entry	Top (consult factory for other options)
Audible Noise @ 2 m	< 75 dB
Energy Storage	Ultracapacitors, electrolytic capacitors

Environment

Operating Altitude	0 – 2,000 m above sea level (without derating)
Operating Temperature	0 – +40°C
Operating Humidity	0 – 90 % relative humidity (non-condensing)

Communication

Communication Protocol	Ethernet / Modbus TCP
Display	7" Color TFT LCD Capacitive Touch Screen Display

Design Standards

UL, CE, IEC, SEMI F47, Samsung Power Vaccine

Limited Warranty

2 Years, Parts & Labor

Falcon CVC Reference Technical Specifications

AC Input

Nominal voltage	200/208/220/380/400/415/ 480/600 VAC
Nominal continuous regulation range	+10%, -20% nominal AC input
Maximum continuous regulation Range	+15%, -27% nominal AC input
Maximum 2 seconds regulation	-40% of nominal AC input (regulated to 90% rated voltage)
Nominal operating frequency	50/60 Hz (auto select)
Operating frequency range	+/- 2 Hz
Nominal efficiency	96.5% at rated load current
Crest Factor (at max current)	2
Termination	Terminal block

AC Output

Overload	Alarm: > 100%, 200 ms Transfer to Static Bypass: >125% 200 ms
Over/Under voltage	Alarm: +/-5% 1 second, Shutdown: > 110% 200ms or <80% more than 10 seconds
Over/Under frequency	Alarm: +/-3 Hz (after 1 second), Shutdown: +/- 5 Hz (after 500 ms)
Voltage Correction Response time	Less than 2 ms

Mechanical

Cabinet construction	Light beige powder-coated galvanneal cabinet
Emergency mechanical bypass	Available as option.
Cabinet environmental rating	IP 20 (for use in protected indoor environments)
Cooling method	Active Convection
Cable entry	Top (consult factory for other options)
Noise	Less than 60dB (1 meter)

Environment

Operating altitude range	From 0 to 2,00 meters above sea level (without derating)
Operating temperature range	0 to +40 °C
Operating humidity range	0 to 90% relative humidity (non-condensing)

Communication

Communication protocol	Ethernet / Modbus TCP
Display	7" LCD Touch Screen Display

Design standards

CE, UL and SEMI F47

Warranty

2 Years

Merlin CVR Reference Technical Specifications

AC Input

Nominal voltage	200/208/220/380/400/415/ 480 VAC
Continuous voltage range	+/- 15%, rated voltage
Nominal operating frequency	50/60 Hz
Operating frequency range	+/- 5 Hz
Nominal Efficiency	95% (half to full rated load)
Termination	Terminal block

AC Output

Voltage	200/208/220/380/400/415/ 480 VAC
Voltage regulation range (optional)	+/- 5 % of rated voltage
Load power factor	0.5 lagging to 0.9 leading
Overload	200% (within circuit breaker trip curve)
Typical load current harmonic distortion factor I(60) / I(RMS)	> 0.7

Performance

Harmonic mitigation	Input current harmonics at point of common coupling: <5% THD, < 3% per HD component Output voltage distortion: < 4% THD, < 2.8% per HD component
Voltage sag protection (optional)	Maximum sag of 50 % nominal voltage for 30 seconds (exceeds SEMI-F47 curve)
Voltage swell protection (optional)	Maximum swell of 30 % nominal voltage for 30 seconds

Mechanical

Cabinet construction	Light beige powder-coated galvalume cabinet
Emergency mechanical bypass	Available as option.
Cabinet environmental rating	IP 20 (for use in protected indoor environments)
Cooling method	Active Convection
Cable entry	Bottom (consult factory for other options)
Noise	Less than 55 dB (1 meter)

Environment

Operating altitude range	From 0 to 2,00 meters above sea level (without derating)
Operating temperature range	0 to +40 °C
Operating humidity range	0 to 90% relative humidity (non-condensing)

Communication

Communication protocol	Ethernet / Modbus TCP
Display	7" LCD Touch Screen Display

Design standards

CE, UL and SEMI F47

Warranty

2 Years

Raptor Eye Monitoring Software



Raptor Eye MONITORING SOFTWARE

- All Raptor products come equipped with **Raptor Eye** monitoring software.
- **Raptor Eye (Local version)** is accessed via the built-in touch screen located on the product.
- **Raptor Eye (Remote Client Application)** can be installed on remote computers for monitoring via direct or Local Area Network connection.
- Various system status values including but not limited to voltage, current, frequency, power, and DC bus voltage can be monitored.
- Voltage sags & swells, as well as fault & alarm event logs are available for viewing and downloading using the software.
- User-adjustable parameters, including nominal voltage, sag/swell trigger set points, sensitivities, and others. (**Raptor Eye (Local version)**)

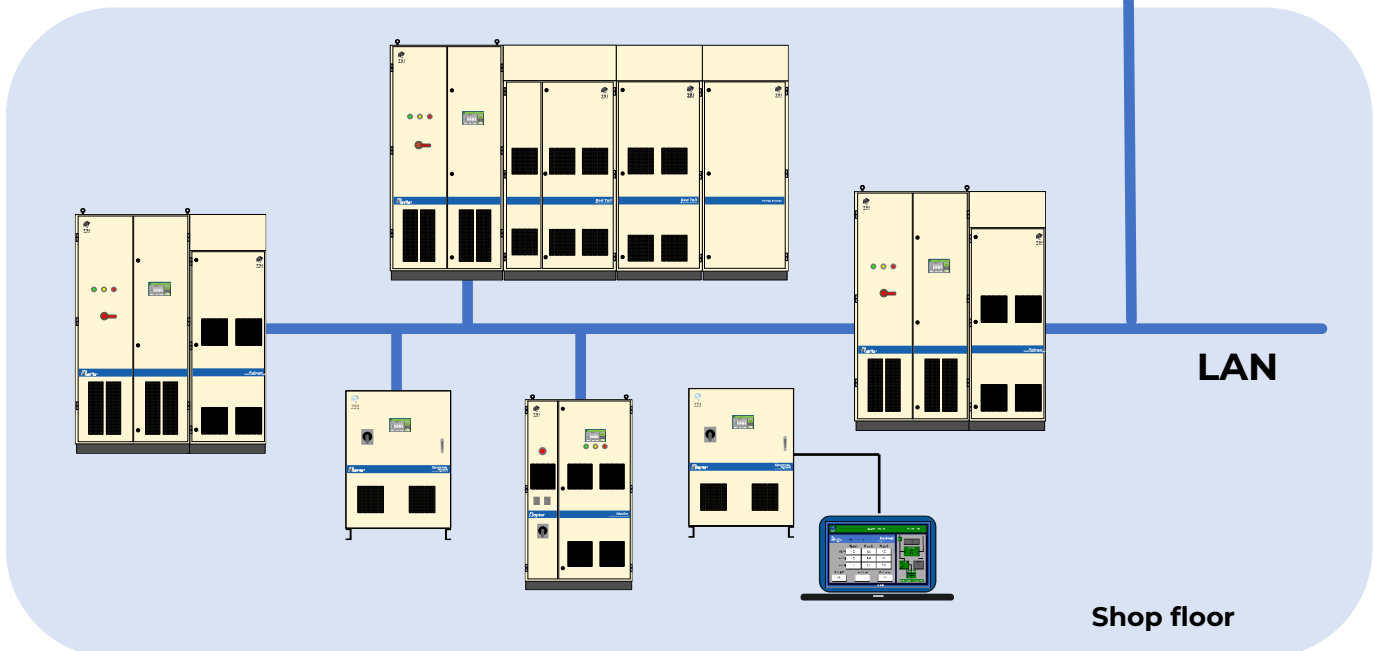
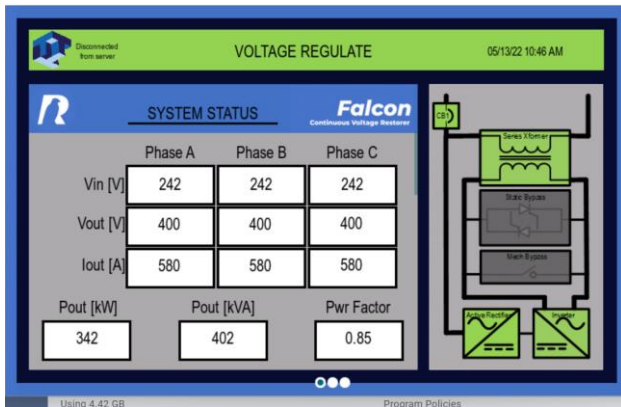

© Copyright 2022, TSI Power Corporation.



TSI Power Corporation

| 1103 W Pierce Avenue, Antigo, WI 54409 USA |
| Tel: + 1-715-623-0636 (US) / + 65-9842-6601(Asia) |
| sales@tsipower.com | www.tsipower.com |



www.tsipower.com